

Nella Aluminium

Surface Mounted Downlights

| | |
|-------------------|---|
| Name | Nella |
| Material | Aluminium |
| Colour | Black or White |
| IP Rating | IP54 |
| IK Rating | IK08 |
| Installation Type | Ceiling - Surface Mounted |
| Diffuser Type | Plastic |
| Lamp Base | Built in LED |
| Max Wattage | 18w |
| Protection Class | 240v = 1 (Requires Earth) 12v DC = 3 (No Earth Required) |
| Lamp Expectancy | <30,000hrs |
| CRI | CRI>80 |
| Dimmable | Yes - Triac (240V Models Only) |
| Warranty | 3 Years Replacement |

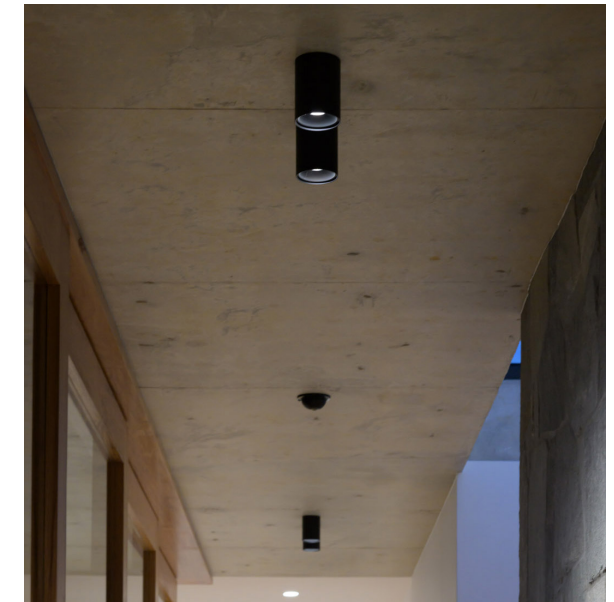
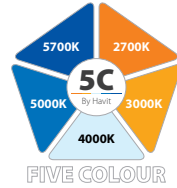

Dimensions

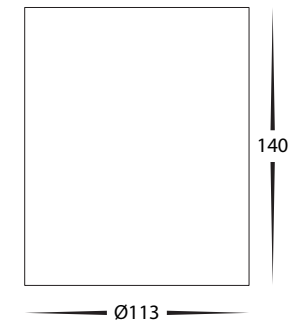

Mounting Base

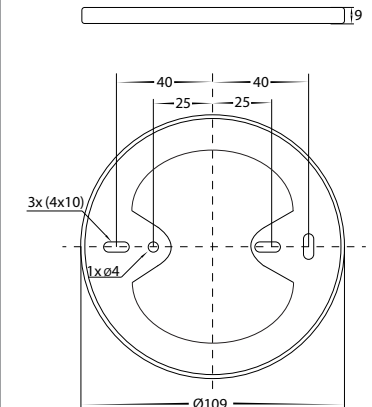

Product Ordering

| Image | Part Number | Colour Temp | Lumens | Input Voltage | Beam Angle | Included LED | Barcode |
|-------|------------------------|---|---|---------------|------------|---------------------------------|---------------|
| | HV5843S-BLK | 2700k 3000k 4000k 5000k 5700k | 1371lm 1410m 1518lm 1600lm 1617lm | 240V AC | 60° | Five Colour 18w Built in LED | 9350418028648 |
| | HV5843S-BLK-12V | | | 12V DC | | | 9350418033055 |
| | HV5843S-WHT | | | 240V AC | | | 9350418028655 |
| | HV5843S-WHT-12V | | | 12V DC | | | 9350418033062 |



Warranty
Terms & Conditions

Website

White



Gold Insert



Black Insert



Chrome Insert



HV58101-GR
Optional Gold ring attachment

Black

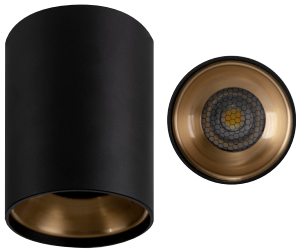

Gold Insert



Chrome Insert



HV58101-GR
Optional Gold ring attachment

Optional Compatible Havit Accessories

| Image | Part Number | Description | Barcode |
|-------|----------------|--|---------------|
| | HV5843-GR | Gold Insert | 9350418028617 |
| | HV5843-BR | Black Insert | 9350418028624 |
| | HV5843-CR | Chrome Insert | 9350418028631 |
| | HV9625 | Triac Dimmer | 9350418001795 |
| | HV5843-BLK-PDT | 3M Pendant Accessory | 9350418035714 |
| | HV5843-WHT-PDT | 3M Pendant Accessory | 9350418035721 |
| | HV58101-GR | Optional gold ring to suit HV5803 HV5815 HV5843 Surface Mounted Downlights | |



HV5843-BLK-PDT
3M Pendant Accessory



HV5843-WHT-PDT
3M Pendant Accessory

Pendant Line Drawing

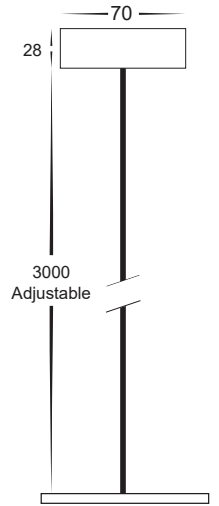

Compatible Drivers for 12v DC Models

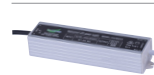

12v DC
LED Drivers

See Catalogue or Website for full range of
12v DC LED Drivers



Compatible
Drivers



Warranty
Terms & Conditions



Website