



# Pacifica DC Ceiling Fan



## The Classic metal style ceiling fans now comes in DC motor!

<b>30W</b> DC MOTOR	<b>48</b> INCH 1220mm	<b>10500</b> m <sup>3</sup> /hr AIRFLOW	<b>56</b> INCH 1420mm	<b>12000</b> m <sup>3</sup> /hr AIRFLOW	<b>ALUMINIUM</b> BLADES	<b>6YR</b> WARRANTY
------------------------	-----------------------------	---	-----------------------------	---	----------------------------	------------------------

22721      22722

6 Speed DC Wall control Included



**CONFORMS TO QBUILD CEILING FAN REQUIREMENT**

Pacifica DC is a classic styled metal fan with 3 easy to fit slide-on blades to make installation a breeze.

- 48 inch (1220mm) or 56 inch (1420mm)
- 30W DC motor
- 10,500m<sup>3</sup>/hr (48inch) / 12,000/hr (56inch) MAX airflow
- 6 Speed DC wall controller (hardwired)
- Summer / Winter function
- Windbreeze function
- Hangsure bracket up to 10 degrees
- 3 x Aluminium blades with Easy-Slide on design for fast installations
- Prewired for lightkit (Light not included)
- ECO green box (no polyfoam)



48 INCH WHITE



56 INCH WHITE



WHITE  
22723/05  
Clipper Light kit  
(sold separately)



WHITE  
22724/05  
Oyster Light Kit  
(sold separately)



### APPLICATIONS

- Bedrooms, lounge and family rooms
- Indoors or enclosed alfresco areas not exposed to the weather



# Pacifica DC Ceiling Fan

## TECHNICAL SPECIFICATIONS

<b>Size</b>	22721: 48 inch (1220mm) 22722: 56 inch (1420mm)
<b>Motor Type</b>	DC (Direct Current)
<b>Operating Voltage</b>	220-240V AC 50Hz
<b>Motor Wattage</b>	30W
<b>Construction</b>	Metal body and canopy
<b>Blade Material</b>	Aluminium (x3)
<b>Ceiling install</b>	Hangsure
<b>Blade Pitch</b>	12 degrees
<b>Ceiling Rake</b>	10 degree max
<b>Control</b>	6 speed wall control with switch included
<b>Warranty</b>	3 year in-home plus 3 year replacement (6-Year) <i>*Limited warranty for wall controller, remote controller and light. Refer to warranty card inside the box for more details.</i>
<b>Standards:</b>	AS/NZS 60335-1 AS/NZS 60335-2-80
<b>Air Movement:</b>	10,500m <sup>3</sup> /hr MAX - 48 inch 12,000m <sup>3</sup> /hr MAX - 56 inch

## INSTALLATION



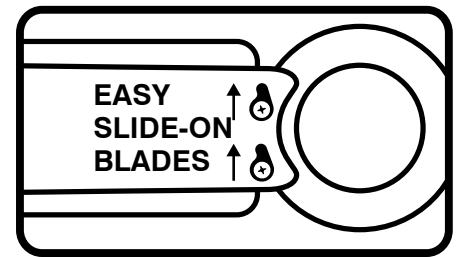
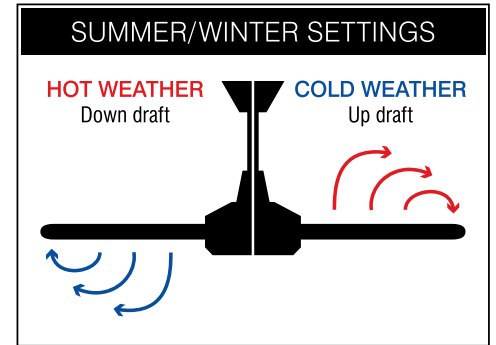

Must be installed by a licensed electrician

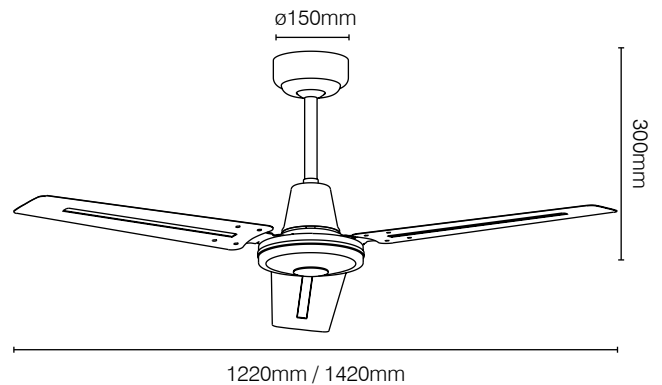

## ACCESSORIES (sold separately)

<b>Extension Rod</b>	
900mm x Ø21mm:	100550/05 white,
1800mm x Ø21mm:	21912/05 White
<b>Light Kit:</b>	
	22724/05 (oyster)
	22723/05 (clipper)



	MODEL	COLOUR	DESCRIPTION	BOX SIZE	GROSS WEIGHT	BOX QTY	BARCODE/TUN
<b>RETAIL BOX</b>	22721/05	White	Pacifica 48 DC Ceiling Fan	W578 x H215 x D274 mm	5.5 kg	1 pc	 9 312641 227212 >
<b>RETAIL BOX</b>	22722/05	White	Pacifica 56 DC Ceiling Fan	W664 x H215 x D274 mm	6.0 kg	1 pc	 9 312641 227229 >
<b>RETAIL BOX</b>	22724/05	White	Pacifica II Oyster Lightkit	W234 x H234 x D95 mm	1.2 kg	1 pc	 9 312641 227243 >
<b>RETAIL BOX</b>	22723/05	White	Pacifica II Clipper Lightkit	W234 x H234 x D95 mm	1.0 kg	1 pc	 9 312641 227236 >